

# ATHMER FINGERSCHUTZ® NR-26 w-proof

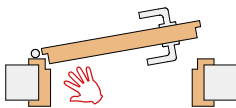

Lieferumfang /  
Included

Montage /  
Fitting

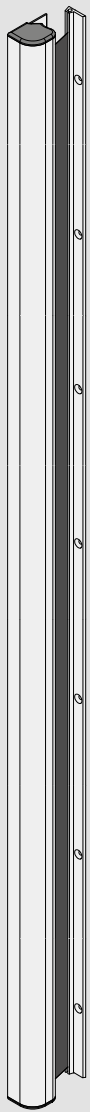

8 X  
8 X

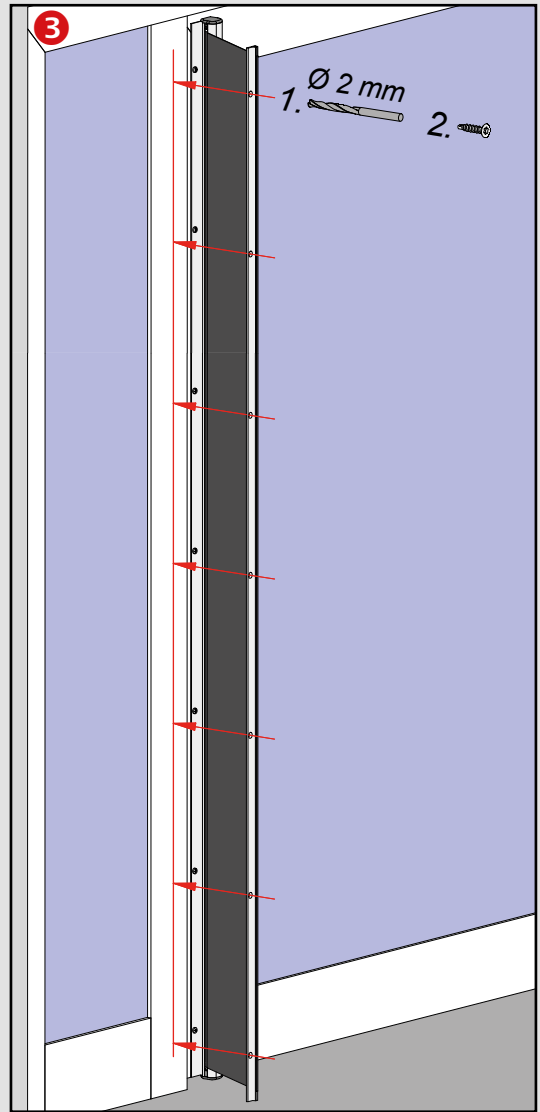
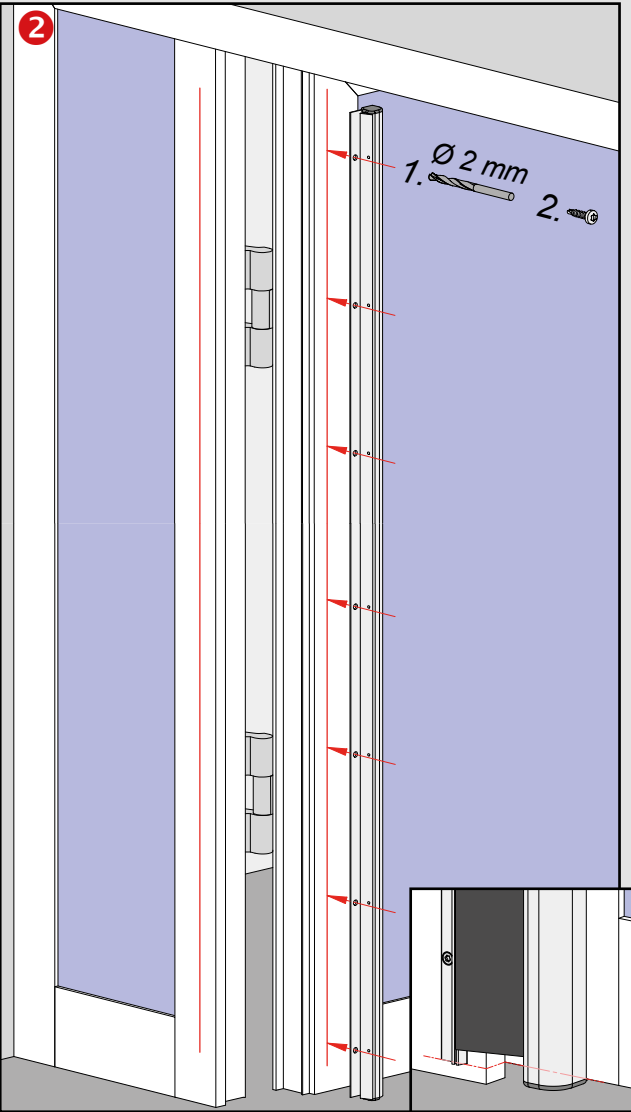
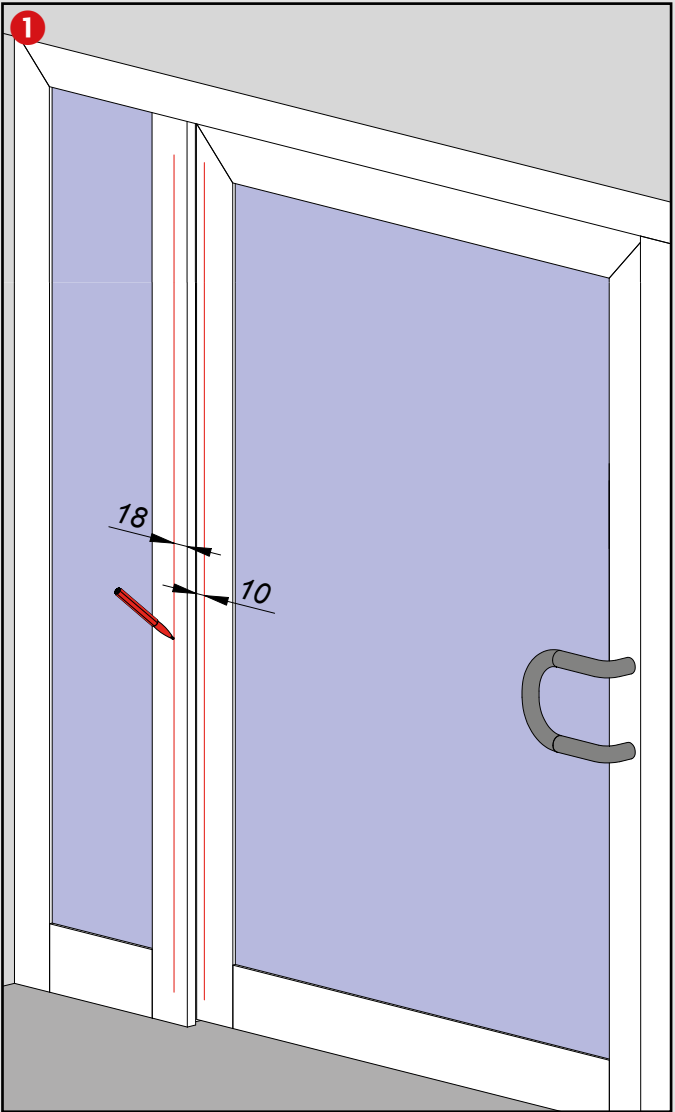

Bitte beachten Sie die alternativen Einbausituationen in den Anwendungsbeispielen. Der Einsatz von Fingerschutz entbindet nicht von der Aufsichtspflicht. Technische Änderungen vorbehalten.  
Please note the alternative installation situations in the application examples. The use of finger protection does not obviate the duty of supervision. Technical specifications are subject to change.

## Anwendung / Technical Specifications

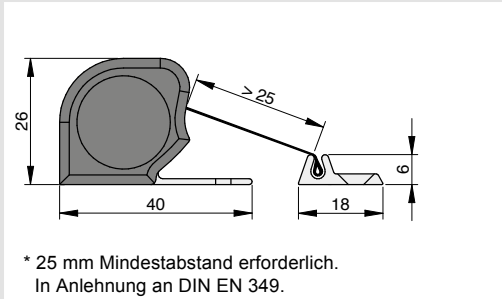
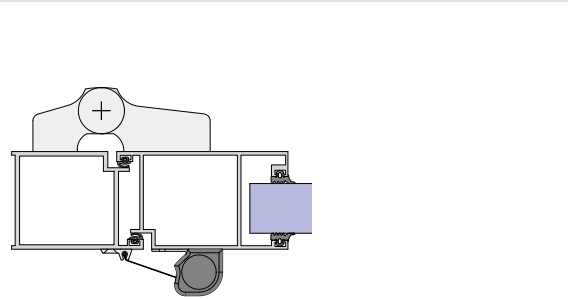
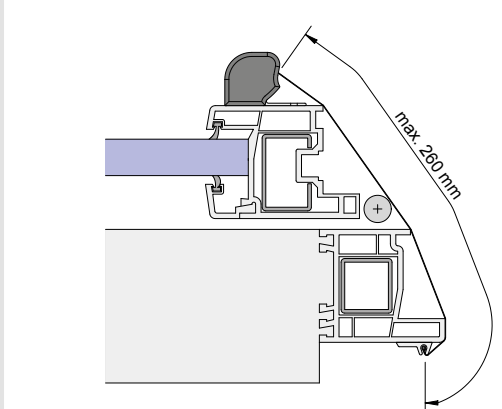
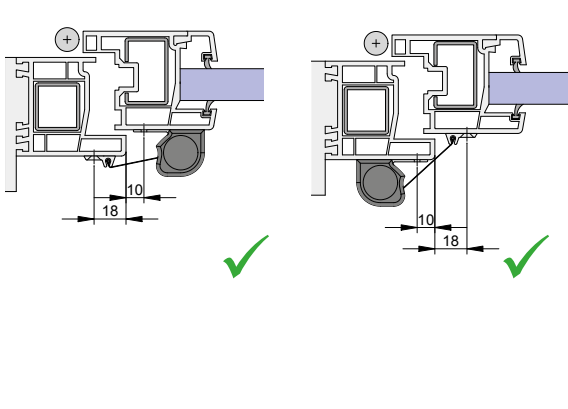

\* 25 mm Mindestabstand erforderlich.  
In Anlehnung an DIN EN 349.

\* 25 mm minimum distance required.  
According to DIN EN 349.

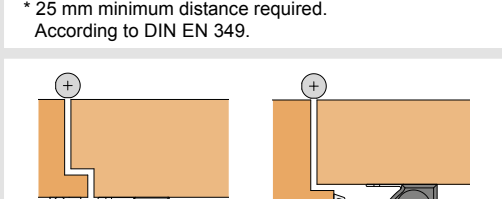
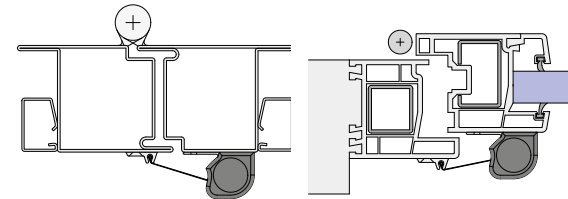

Schrauben für Metall- und Kunststofftüren sind  
im Lieferumfang enthalten.

Screws for metal and plastic doors are included in delivery.

Schrauben für Holztüren bauseits.  
Optional Art.-Nr. 5831: Spanplattenschrauben Ø 3,5 x 16 mm

Screws for wooden doors must be provided on site.  
Optional Art.-No. 5831: chipboard screw Ø 3,5 x 16 mm

## ATHMER BANDSEITIGE SCHUTZPROFILE

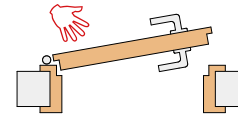

Zur vollständigen Absicherung der Nebenschließkante gehört auch immer die Absicherung der Bandseite. Dazu empfehlen wir die Athmer bandseitigen Schutzprofile als Set. Das Set enthält ein Profil zur Absicherung zwischen den Bändern und ein Profil für den Bereich unterhalb des unteren Bandes.

To ensure a complete protection of the auxiliary edge of a door, also the protection of the hinge side is essential. For this we recommend the Athmer protective profiles at the hinge side as a set. The set contains a profile for the protection of the part between the hinges and one for the protection of the part below the lower hinge.

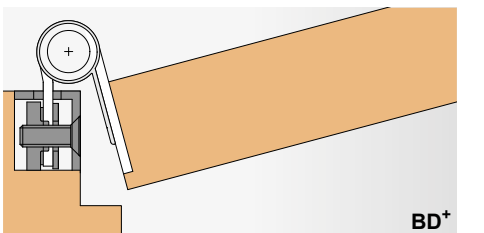
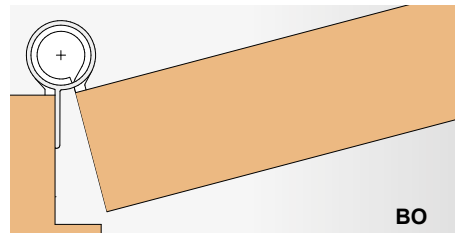
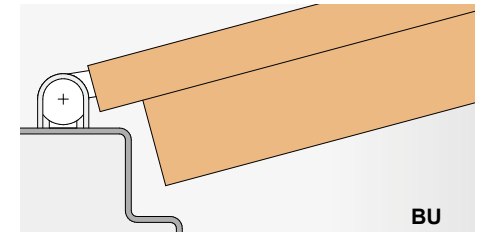
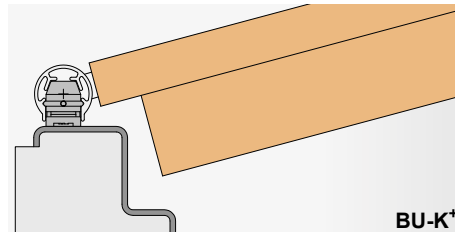
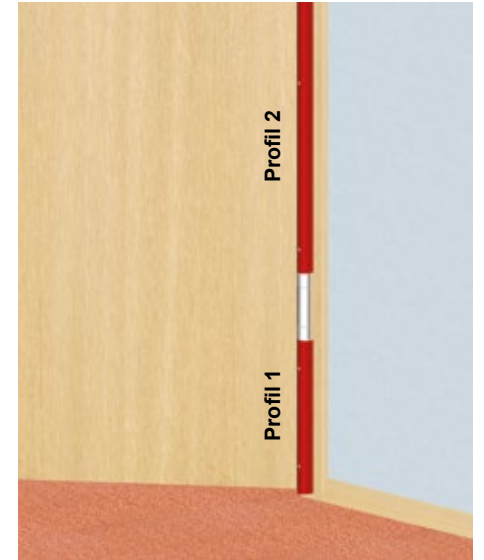

Bitte beachten Sie die alternativen Einbausituationen in den Anwendungsbeispielen. Der Einsatz von Fingerschutz entbindet nicht von der Aufsichtspflicht. Technische Änderungen vorbehalten.  
Please note the alternative installation situations in the application examples. The use of finger protection does not obviate the duty of supervision. Technical specifications are subject to change.

